INSTRUCTION MANUAL

OPERATION & MAINTENANCE

TECHNICAL MANUAL



This is a hazard alert symbol: ⚠ When you see this symbol, be aware that personal injury or property damage is possible. The hazard is explained in the text following the symbol. Read the information carefully before proceeding.

The following is an explanation of the three different types of hazards:

- ⚠ **DANGER:** Severe personal injury or death will occur if hazard is ignored.
- ⚠ **WARNING:** Severe personal injury or death can occur if hazard is ignored.
- ⚠ **CAUTION:** Minor injury or property damage can occur if hazard is ignored.

- ⚠ **DANGER:** Do not pump flammable or explosive gases or operate the unit in an atmosphere containing them.
- ⚠ **CAUTION:** The pump is designed for air only. Do not allow corrosive gases or particulate material to enter the pump. Water vapor, oil-based contaminants, or other liquids must be filtered out.
- ⚠ **CAUTION:** Ambient temperature should not exceed 40°C(104° F). For operation at higher temperatures, consult the factory.
- ⚠ **CAUTION:** Close supervision is necessary when any appliance is used by or near children.

This pump's function is to pump air and under no circumstances should it be used to pump any other gases. The pump must not be used for the pumping of fluids, particles, solids or any substance mixed with air, particularly combustible substances likely to cause explosions.

Never lubricate this oil-less pump, the moving parts consist of an actuating rod supported by two special synthetic rubber diaphragms which vibrate laterally, permitting long-term continuous operation. Operation is based upon the principle of electromagnetic vibration which eliminates the need for sliding parts, thereby minimizing power consumption and offering high efficiency.

INSTALLATION

- ⚠ **WARNING:** To avoid risk of electrocution do not use this product in an area where it could become submerged in water or other liquids. The Canadian (c-UL) pumps need to be stored in a dry location and it is not intended for outdoor use.
- ⚠ **CAUTION:** Do not block the flow of cooling air around the pump in any way. The life of pump may be reduced or malfunction could occur, if hazard is ignored.

GROUNDING INSTRUCTIONS

FOR ALL GROUNDED, CORD-CONNECTED PRODUCTS

This product should be grounded. In the event of an electrical short circuit, grounding reduces the risk of electric shock by providing an escape wire for the electric current. This is equipped with a cord having a grounding wire with an appropriate grounding plug.

The plug must be plugged into an outlet that is properly installed and grounded in accordance with all local codes and ordinances.

⚠ DANGER: Improper installation of the grounding plug can result in a risk of electric shock. If repair or replacement of the cord or plug is necessary, do not connect the grounding wire to either flat blade terminal. The wire with insulation having an outer surface that is green, with or without yellow stripes, is the grounding wire.

Check with a qualified electrician or serviceman if the grounding instructions are not completely understood, or if in doubt as to whether the product is properly grounded. Do not modify the plug provided; if it will not fit the outlet, have the proper outlet installed by a qualified electrician.

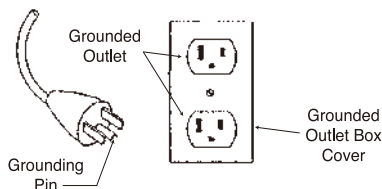

For a grounded, cord-connected product rated less than 15 amperes and intended for use on a nominal 120 volt supply circuit.

This product is for use on a nominal 120 volt circuit, and has grounding plug. Make sure that the product is connected to an outlet having the same configuration as the plug. No adapter should be used with the product.

FOR PERMANENTLY CONNECTED PRODUCT

This product should be connected to a grounded, metallic, permanent wiring system, or an equipment-grounding terminal or lead on the product(refer to wiring diagram).

WIRING

120V AC Wiring Diagram

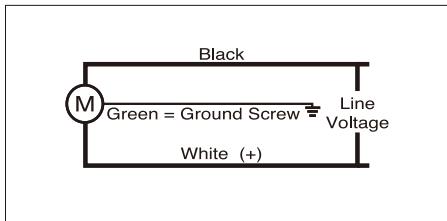

EXTENSION CORDS

Use only a 3-wire extension cord that has a 3-blade grounding plug, and a 3-slot receptacle that will accept the plug on the product. Make sure your extension cord is in good condition. When using an extension cord, be sure to use one heavy enough to carry the current that your product will draw.

A cord no longer than 100 feet, No.16 AWG extension cord should be used. An undersized cord will cause a drop in line voltage resulting in loss of power and overheating. For outdoor use, use an extension cord that is approved for outdoor use, marked W-or W-A.

MOUNTING

⚠ CAUTION: When using the pump to inject air into a liquid, make sure that the pump is higher than the surface level of the liquid, otherwise that liquid may run back into the pump if the power is interrupted.

The pump should be in an upright, level position and remain on a stable, rigid operating surface for proper operation.

PLUMBING

Improper connection will cause leakage of air.

Connect the pumps exhaust port and PVC(plastic)pipe with an L-shaped rubber hose. Be sure to secure place of connection with a hose tightening clip(Refer to Fig.1).

Fig. 1

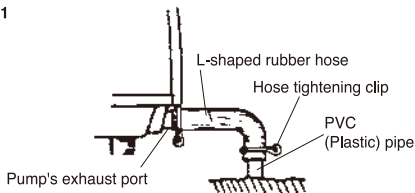

STORAGE

Store indoors out of the weather in a dry area. Make certain the electrical cord is placed so there will be no chance of damage.

⚠ CAUTION: To avoid risk of electrocution or damage to the pump do not store this unit where it could come into contact with water or other liquids. Store indoors. Inspect compressor and cord for damage prior to putting compressor back into service.

OPERATION

⚠ WARNING: Lower housing and pump surfaces can become very hot during operation. Do not touch these surfaces until unit has been shut off and allowed to cool.

⚠ CAUTION: Carefully examine the air pump after installation. It should not be plugged in if there is water on parts not intended to be wet.

⚠ CAUTION: Do not operate if the cord or plug is damaged, or if the pump is malfunctioning, dropped, or damaged in anyway.

⚠ CAUTION: Ensure pump is securely mounted prior to operation.

When alternating current is applied to electromagnet as in the figures, the actuating rod moves first in the arrow direction shown in Fig. 2A and then in the arrow direction shown in Fig. 2B, by the magnetic attraction and repellent forces exerted between the electromagnet and the permanent magnets attached to the rod.

The rod vibrates at the power supply(60Hz/50Hz)frequency and changes the volume of the space enclosed between the head(casing) and the diaphragm. Thus, air intake, compression, and exhaust, can be performed as the rod vibrates.

Fig. 2A

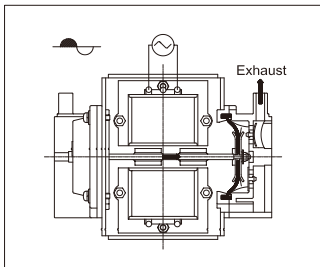
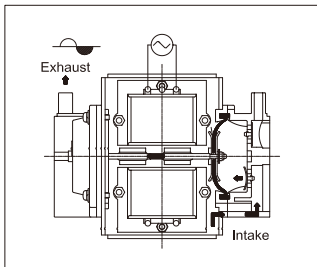

Fig. 2B



MAINTENANCE

⚠ WARNING: Always disconnect power before installing or servicing. Failure to do so could result in electrical shock, personal injury or death. The motor may be thermally protected and will automatically restart when it cools, if the thermal protection switch is tripped.

⚠ CAUTION: The filters must be periodically cleaned or replaced. A clogged filter can cause overheating or pump failure.

Any servicing of the unit other than that recommended in the instruction manual must be performed by an Authorized Service Facility. Inspection of filters is suggested every three months.

When inspecting filter, also clean inlet port area of filter and housing. Filters can be cleaned with soap and water. Be sure to dry all parts and filter well before reinstalling. If the pump makes an abnormal noise, or the amount of discharged air is greatly decreased, turn off the power immediately.

For repairs or replacement parts, please contact the factory, or send unit to an Authorized Service Facility.

Cleaning the filter (Refer to Fig.3)

REPLACEMENT FILTERPAD PART#	
40 liter model.....	40PA000010
60/80 liter models.....	80PA000040
100/100LL/120/120LL/150/200 liter models.....	120PA20010

- Undo the truss screw securing the cover to the pump housing, and remove the Filter pad.
- Gently dust the Filter pad then hand-wash in mild soapy water and be sure to dry well before reinstalling
- Replace the Filter pad and cover. Secure with the truss screw.

Fig. 3

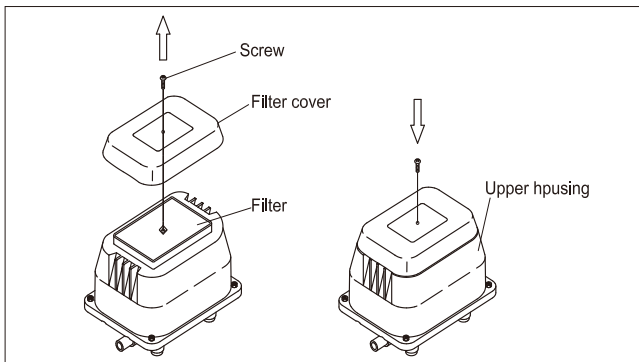

Changing the Pump (Chamber) Assembly-HP Series

REPLACEMENT PUMP ASSEMBLY PART#	CONTENTS
40 liter model..... 40PC000030	Head (Casing) block
60/80 liter models80PC20010P	Diaphragm mounting block
100/120 liter models..... 120PC2010P	Hex nut (U-lock nut) / washer
100LL/120LL liter models 120PC2020P	
150/200 liter models.....200PC2010P	

[1] Remove the Head (Casing) block (Refer to Fig.4)

- Remove the four corner screws(Refer to Fig.4-①), and the Upper housing. (Refer to Fig.4-②) If stuck, insert screwdriver between exhaust outlet and Upper housing, and gently pry apart.
- Remove the Sound absorber. (Refer to Fig.4-②, except for 40 liter model,100LL liter model,120LL liter model)
- Remove the screws from all the corners of Frame cover for subsequent removal of the Frame cover. (For 100/120 liter models, Refer to Fig.4-④)
- Undo the hose band and remove the L-tube from the Head (Casing) block.
- Remove screws attaching the Head (Casing) to the pump mechanism, and remove Head (Casing) block. (Refer to Fig.4-③. For 100/120 liter models, Refer to Fig.4-⑤)

Fig. 4

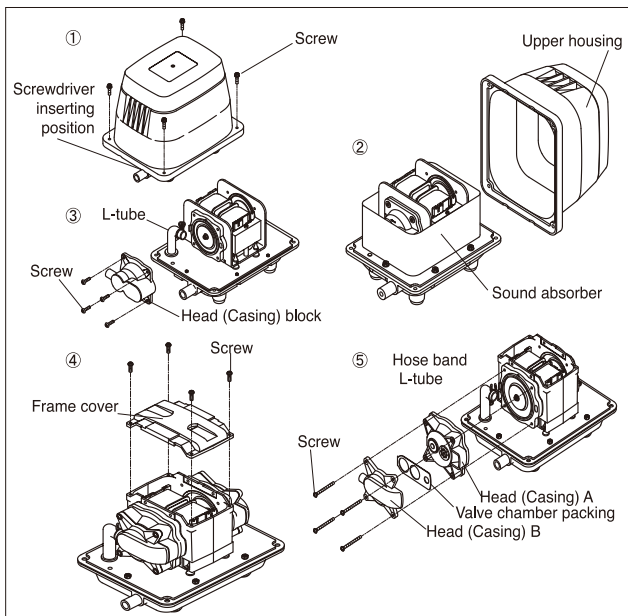

[2] Replacing Diaphragm mounting block (Refer to Fig.5)

- After removing Head (Casing) block, remove one of the hex nut (U-lock nut) and washer in the center of the diaphragm.
- Remove one of the Diaphragm mounting blocks from the Rod, and pull out the other Diaphragm mounting block from the pump body together with the Rod without loosening its hex nut (U-lock nut) and washer. (Refer to Fig.5-①)
- Then remove the other Diaphragm mounting block from the Rod. (Refer to Fig.5-②)
- Reattach a new Diaphragm mounting block on one side of the Rod with new hex nut (U-lock nut) and washer, insert the Rod in accordance with the procedure reverse to that performed when the Rod was removed the pump.
- Reattach washer and new hex nut (U-lock nut) to Rod screw protruding through other Diaphragm mounting block and tighten.

Fig. 5

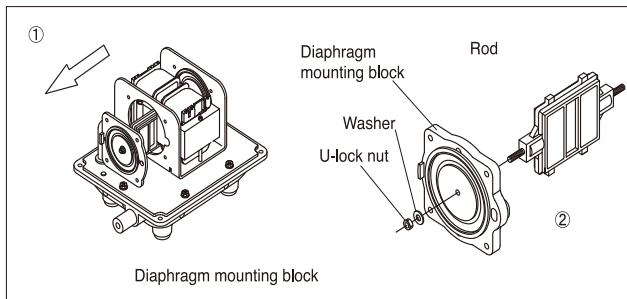

After the Diaphragm mounting block have been installed, replace with the new Head (Casing) block, reattaching the L-tube, and reinstall the 4 screws holding the Head (Casing) on. (Refer to Fig.4-③or⑤)

[3] Restartable automatic stop switch

SR Switch(For 60/80/100/100LL/120/120LL/150/200 liter models)

1.Overview

The body of the switch is set on the upper part of the rod.

If the rod becomes unbalanced or abnormal vibration occurs due to the damaged Diaphragm, the pump stops operation automatically to prevent any further damage.

The work for restart pump is easier and more visible than previous design by adopting SR switch that can be worked by sliding the switch slide.(Fig6)

Fig. 6

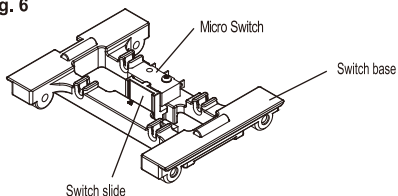

2.How to restart

Warning

Do not touch the power plug and the pump body with wet hands. This can result in electrical shock. When you work with pumps, make sure the pump is disconnected from power outlet.

Caution

When you work with pumps, make sure the pump is disconnected from power outlet.

If the pump remains connected to the electricity supply, moving parts may cause injury or there is a possibility of electrocution.

Please make sure to reset the switch after replacement of diaphragm.

Resetting the switch without replacement of diaphragm can damage the switch and be a cause of failure.

1) Pinch both sides of the switch slide and slide it to the center position of the switch base until it clicks into place.

At this time, check that the protrusion of the switch slide is adjusted to the position of "▲" mark and switch part of the micro switch is pressed. (Fig7, Fig8)

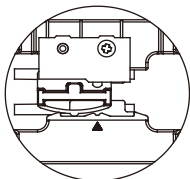

Fig. 7 Non-Operating State

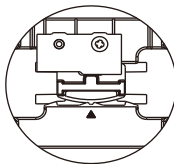
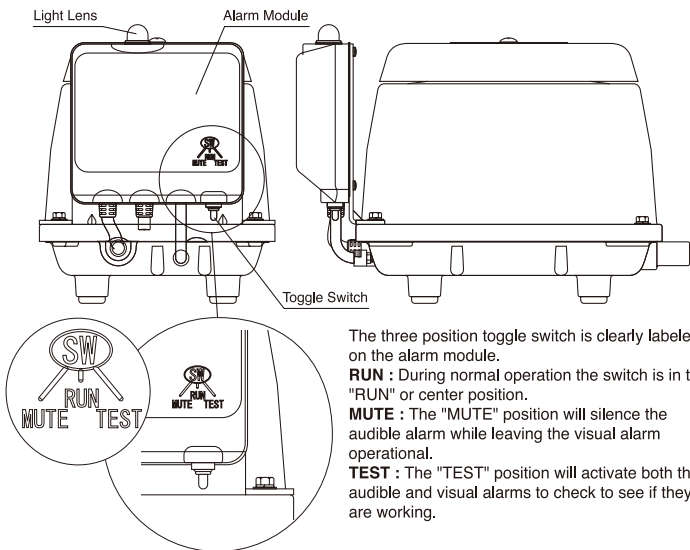

Fig. 8 Reset position

Operation of Compressor Alarm Module

General Information

- ⚠ **Danger:** Do not attempt to open the alarm module. If the unit is connected to electricity, opening of the alarm module can result in a risk of electric shock.
- ⚠ **Danger:** Service of the alarm module should only be done by a qualified electrician or serviceman.
- ⚠ **Danger:** If the outside of the alarm module or light lens becomes cracked or damaged, unplug or shut-off the electric power immediately and contact an electrician or serviceman.
- ⚠ **Caution:** Do not carry the unit by the alarm module or electrical cord. It could damage the alarm module.



In Case of an Alarm :

The alarm module audible alarm (buzzer) and visual alarm (light) are intended to signal a system malfunction. Contact your service provider whenever you hear or see the alarm when the switch is in the "RUN" or center position. The "MUTE" position can be used to silence the audible alarm until the service provider arrives.

TROUBLE SHOOTING

Symptom	Possible cause	Point to check up	Remedy
Pump fails to work	Electrical connection	Plug and outlet	Plug securely into outlet
	Wire cut inside the cord	Check with tester	Change power cord, electromagnet or lead wire
	SR switch activated	<div style="border: 1px solid black; padding: 5px;"> Check <ul style="list-style-type: none"> • Switch Slide • Chamber Block </div>	Exchange diaphragm
Pump works but makes loud, irregular noise	Diaphragm damaged		
	Faulty valve	Remove upper, lower housing and trace the source of cause	Exchange casing or diaphragm mounting block
	Faulty chamber block		
	Faulty filter	Filter clogged	Clean up filter
	Valve chamber cover out of place	Faulty tube	Repair or replace with new one
Pump works but no air comes from reservoir	Faulty piping connection	Rubber hose out of place, broken	Connect properly or replace with new one
	Pump runs normally	Air piping clogged	Clean property